

# POLYCOM® VVX® 450

## Quick Start Guide



The following figure displays the hardware features on the VVX 450 business media phones. The table lists each numbered feature shown in this figure.

### VVX 450 HARDWARE FEATURES

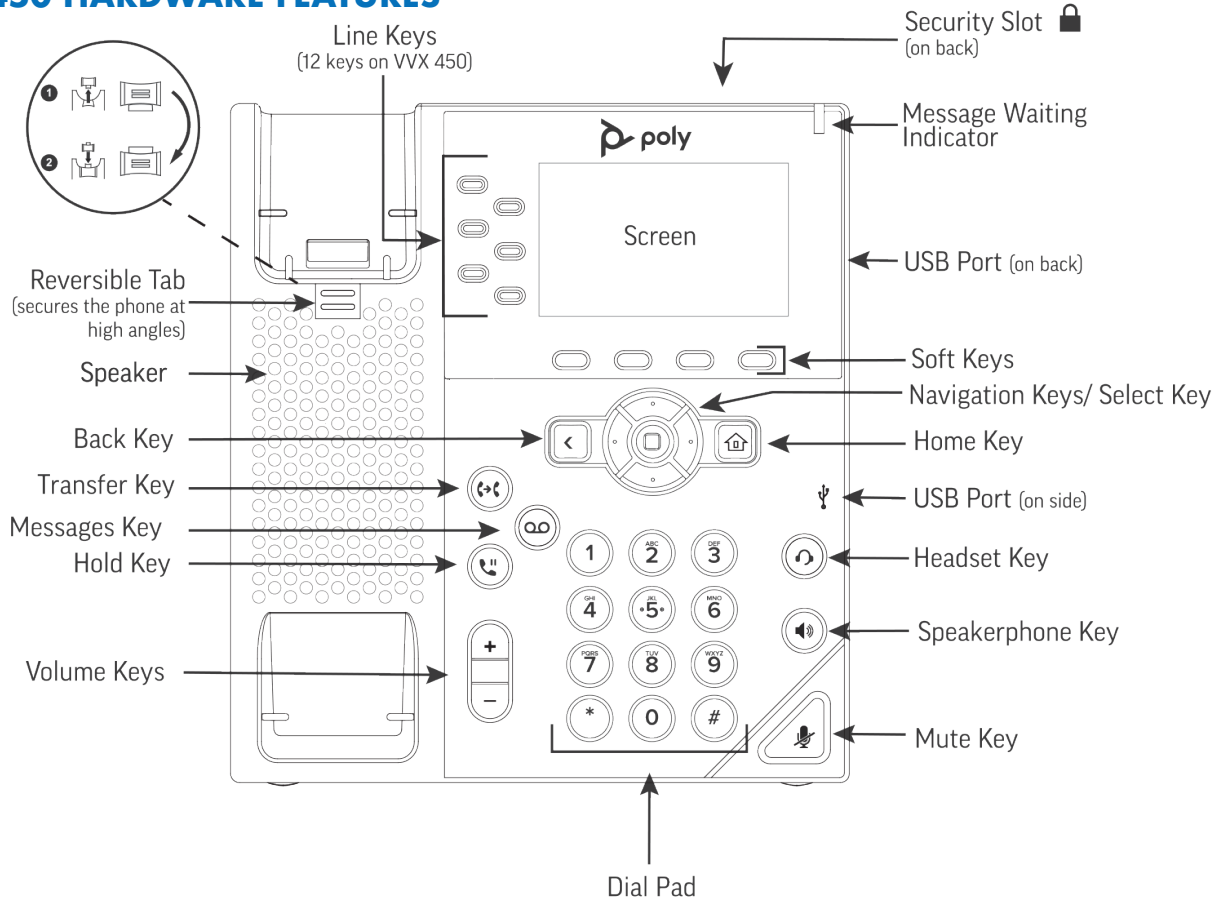

Feature	Description
Security slot (on top)	Enables you to attach a universal security cable lock to your phone so you can secure it to a desktop.
Speaker	Provides ringer and hands-free (speakerphone) audio output.
Dialpad	Enables you to enter numbers, letters, and special characters. You can also use the dialpad keys to select menu items that have index numbers.
Message Waiting Indicator	Flashes red to indicate new messages.
Home key	Enables you to press  from any screen to display <b>Home</b> view. From home view, press  to display other phone views.
Screen	Shows a 2.2-inch diagonal screen with a backlight.
Navigation keys/Select key	Scrolls through information or options displayed on the phone's screen. Selects a field of displayed data.

For more information, visit [epb.com/customer-support/business-support](http://epb.com/customer-support/business-support) or call 423-648-1500, option 2



















Feature	Description
Security slot (on top)	Enables you to attach a universal security cable lock to your phone so you can secure it to a desktop.
Speaker	Provides ringer and hands-free (speakerphone) audio output.
Dialpad	Enables you to enter numbers, letters and special characters. You can also use the dialpad keys to select menu items that have index numbers.

## NAVIGATING YOUR PHONE INTERFACE

**Home Screen:** On VVX 450 phones, the phone line and icons you can select to access phone features, settings, and information display on the home screen. A Page Indicator shows the page you are currently viewing.

**Calls Screen:** The Calls screen is supported on VVX 450 phones. You can access the Calls screen when you have one held call or an active and held call in progress on your phone. The Calls screen is automatically displayed when you have an active call and one or more held calls on your phone.

**Lines Screen:** The Lines screen is supported on VVX 450 phones and is the default screen when your phone is not in use. You can view your phone lines, favorites and soft keys on the Lines screen. To display the Lines screen, press the home key.

Icon	Description	Icon	Description
	Registered line		Phone warning
	Unregistered line		Login credentials invalid
	Placing a call		Shared line
	Active call using Polycom HD Voice		Shared line with a held call
	Held call		Call forwarding is enabled
	Incoming call		New messages
	Active conference		Missed call
	Placed call		Do Not Disturb enabled
	Received call		