

POLYCOM® VVX® 350



Quick Start Guide

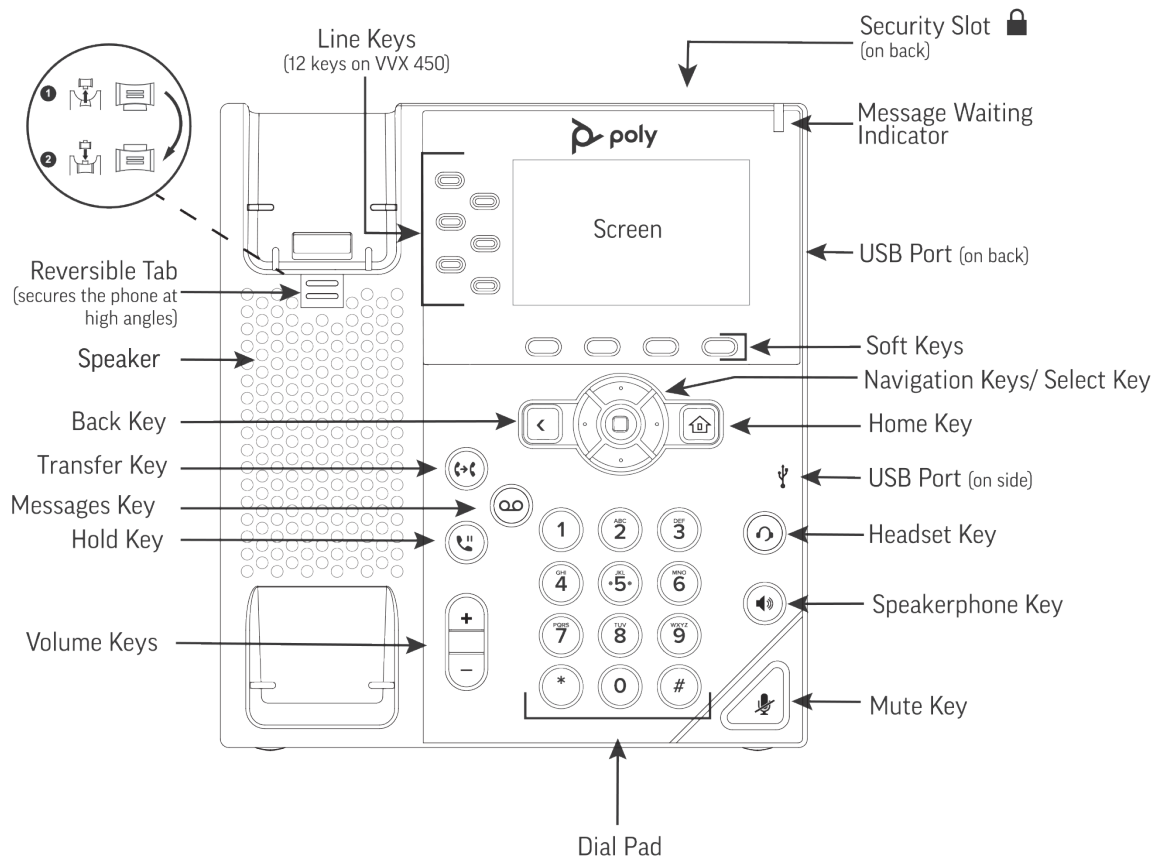

The following figure displays the hardware features on the VVX 350 business media phones. The table lists each numbered feature shown in this figure.

VVX 350 HARDWARE FEATURES



Feature	Description
Security slot (on top)	Enables you to attach a universal security cable lock to your phone so you can secure it to a desktop.
Speaker	Provides ringer and hands-free (speakerphone) audio output.
Dialpad	Enables you to enter numbers, letters, and special characters. You can also use the dialpad keys to select menu items that have index numbers.
Message Waiting Indicator	Flashes red to indicate new messages.
Home key	Enables you to press  from any screen to display Home view. From home view, press  to display other phone views.
Screen	Shows a 2.2-inch diagonal screen with a backlight.
Navigation keys/Select key	Scrolls through information or options displayed on the phone's screen. Selects a field of displayed data.

For more information, visit epb.com/customer-support/business-support or call 423-648-1500, option 2



























Feature	Description
Headset key	Enables you to place and receive calls through a headset. The key glows green when an analog headset is activated.
Speakerphone key	Enables you to place and receive calls using the speakerphone. The key glows green when activated.
Mute key	Mutes your audio during calls and conferences. The key glows red when audio is muted.
Volume keys	Adjusts the volume of the handset, headset, speaker, and phone's ringer.
Microphone	Transmits sound from your phone to other phones.

NAVIGATING YOUR PHONE INTERFACE

Home Screen: On VVX 350 phones, the phone line and icons you can select to access phone features, settings, and information display on the home screen. A Page Indicator shows the page you are currently viewing.

Calls Screen: The Calls screen is supported on VVX 350 phones. You can access the Calls screen when you have one held call or an active and held call in progress on your phone. The Calls screen is automatically displayed when you have an active call and one or more held calls on your phone.

Lines Screen: The Lines screen is supported on VVX 350 phones and is the default screen when your phone is not in use. You can view your phone lines, favorites, and soft keys on the Lines screen. To display the Lines screen, press the home key.

Icon	Description	Icon	Description
	Registered line		Phone warning
	Unregistered line		Login credentials invalid
	Placing a call		Shared line
	Active call using Polycom HD Voice		Shared line with a held call
	Held call		Call forwarding is enabled
	Incoming call		New messages
	Active conference		Presence status (Available)
	Placed call		Presence status (Busy or In a Call)
	Received call		Presence status (Away)
	Missed call		Presence status (Do Not Disturb)
	Favorite		Presence status (Offline)
	Do Not Disturb enabled		Presence status (No information)